

SIGN	DATE	DESCRIPTION	APPROVER
▲	20180123	Add "Nexttron" LOGO and nut post height	JACKY LIU

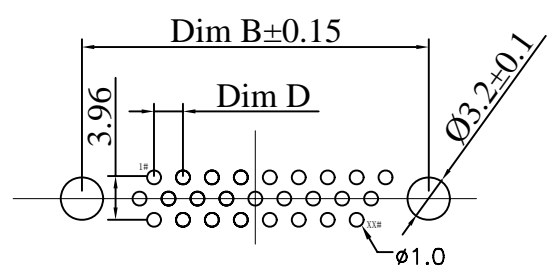

POS. NO.	A	B	C	D	E	F
78P	52.86	61.10	67.10	2.41	11.11	15.30
62P	55.42	63.50	69.32	2.41	8.36	12.50
44P	38.96	47.04	53.04	2.29	8.36	12.50
26P	25.25	33.32	39.14	2.29	8.36	12.50
15P	16.92	24.99	30.81	2.29	8.36	12.50

P. C. BOARD LAYOUT

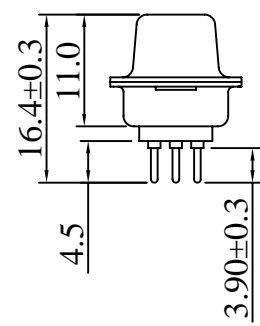
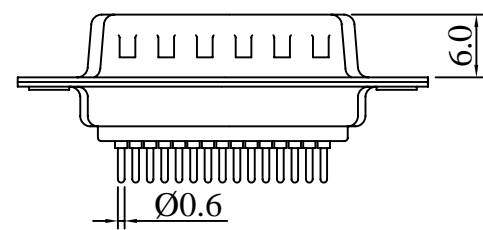
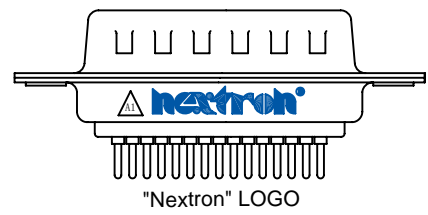
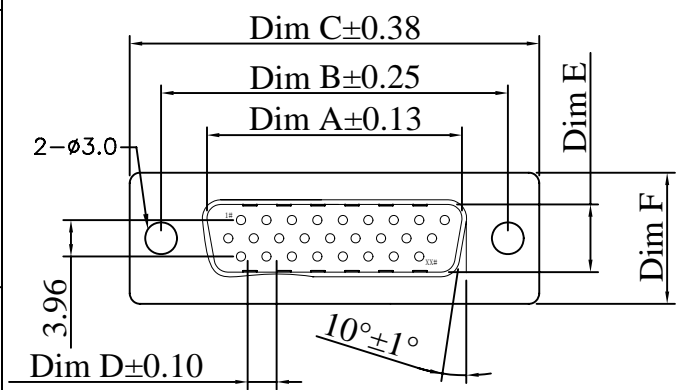
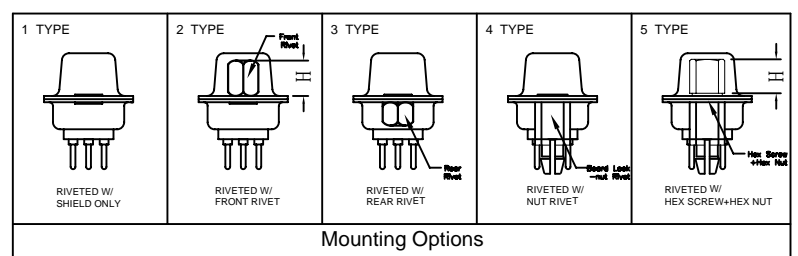

SPECIFICATIONS:

- Current rating:3.0A AC/DC
- Voltage rating:250V AC/DC
- Contact resistance:30m ohm MAX
- Insulation resistance:1000M ohm MIN
- Withstanding voltage:1000V AC for one minute
- Operating temperature range:-40°C~+85°C

MATERIAL AND FINISH

- Insulator:PBT+30%G.F(UL94V-0)
- Contact:Copper Alloy Nickel Undercoated
- Selective Gold Plated
- Finish:Metal Iron With Tin Plated

Ordering Information

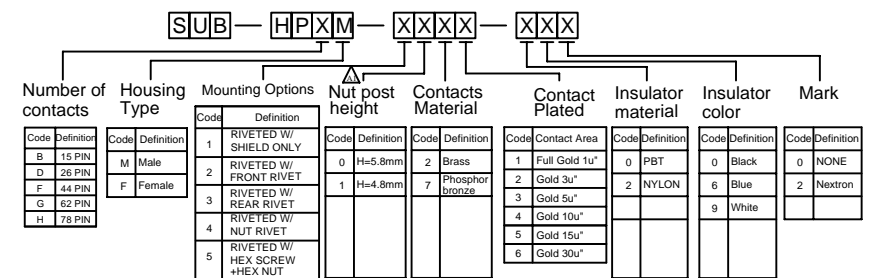

JHJM 深圳市君灏精密工业有限公司
SHENZHEN JUNHAO ENGINEERING CO., LTD

PART. NAME: D型XX芯高密度直插式PCB焊接插座(针)				TITLE: D-SUB/HDP/xxP/MALE	
PART. NO.: SEE TABLE				DWG NAME: C-SUB-HP0M-0001	
APPROVED BY	CHECKED BY	DESIGNED BY	DRAWN BY	CUSTOM NO.:	Tolerance
Jonnson	Jeff	allan	Jacky		x. ±0.50
			2019.01.23		x.x ±0.30
					x.xx ±0.20
					xx° ±1°